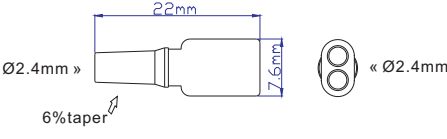
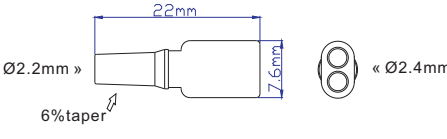
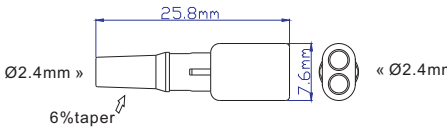
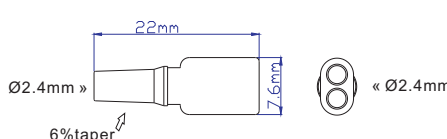
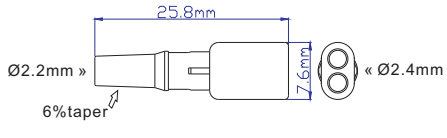
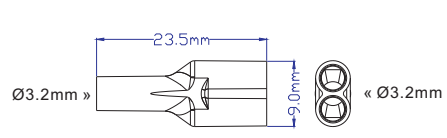

BI-CONNECTOR

Code	Material	Product Drawing	Product Description
A04009	PVC		<p>MINI-BI-CONNECTOR Tubing Pocket :D2.4mm Color :Light Blue Tinted For Tube OD2.35-2.45mm</p>
A04075	PVC		<p>MINI-BI-CONNECTOR Tubing Pocket :ID2.2/2.4mm Color :Light Blue Tinted For Tube OD2.15-2.25mm & Tube OD2.35-2.45mm</p>
A04010	ABS		<p>MINI-BI-CONNECTOR -Longer Tubing Pocket :ID2.4mm Color :Clear For Tube OD2.35-2.45mm</p>
A04011	ABS		<p>MINI-BI-CONNECTOR Tubing Pocket :ID2.4mm Color :Clear For Tube OD2.35-2.45mm</p>
A04012	ABS		<p>MINI-BI-CONNECTOR -Longer Tubing Pocket :ID2.2/2.4mm Color :Clear For Tube OD2.15-2.25mm & Tube OD2.35-2.45mm</p>
A04015	PVC		<p>3-Way Connector ID 3.2mm Tubing Pocket :ID3.2mm Color :Clear For Tube OD3.15-3.25mm</p>

Note :

Scale 1:1

BI-CONNECTOR

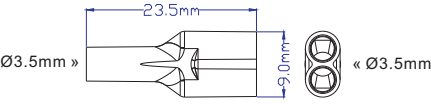
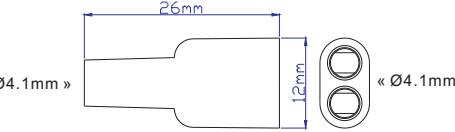
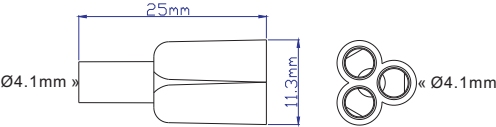
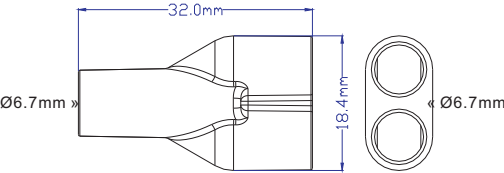
Code	Material	Product Drawing	Product Description
A04014	PVC		<p>3-WAY CONNECTOR Tubing Pocket :ID3.5mm Color :Light Blue Tinted For Tube OD3.45-3.55mm</p>
A04050	PVC		<p>3-WAY CONNECTOR Tubing Pocket :ID4.1mm Color :Light Blue Tinted For Tube OD4.05-4.15mm</p>
A04016	PVC		<p>4-WAY CONNECTOR Tubing Pocket :ID4.1mm Color :Light Blue Tinted For Tube OD4.05-4.15mm</p>
A04013	PVC		<p>3-WAY CONNECTOR Tubing Pocket :ID6.7mm Color :Clear For Tube OD6.65-6.75mm</p>

Note :

Scale 1:1

T-CONNECTOR

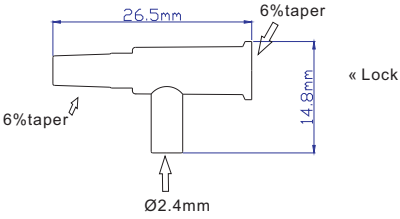
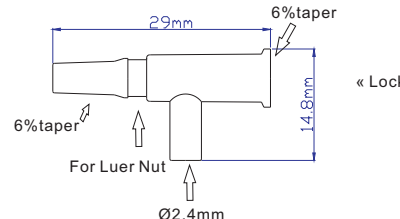
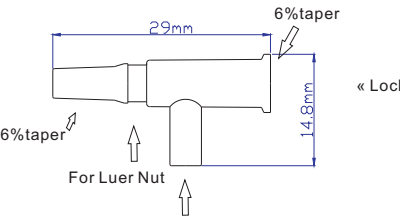
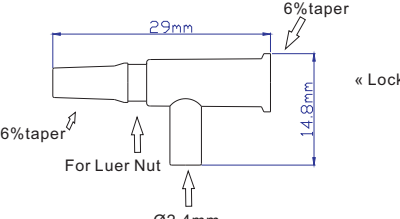
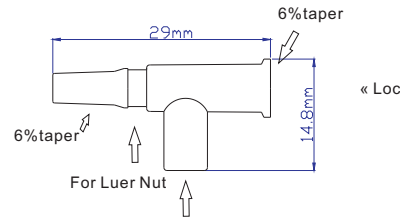
Code	Material	Product Drawing	Product Description
A04004	ABS		<p>T-connector Tubing Pocket :ID2.4mm Color :Clear For Tube OD2.35-2.45mm</p>
A04005	ABS		<p>TL-connector Tubing Pocket :ID2.4mm Color :Clear For Tube OD2.35-2.45mm With Luer Nut addible</p>
A04006	PVC		<p>TL-connector Tubing Pocket :ID2.4mm Color :Light Blue Tinted For Tube OD2.35-2.45mm With Luer Nut addible</p>
A04007	Polycarbonate		<p>TL-connector Tubing Pocket :ID2.4mm Color :Lavender Tinted For Tube OD2.35-2.45mm With Luer Nut addible</p>
A04051	ABS		<p>TL-connector Tubing Pocket :ID4.1mm Color :Clear For Tube OD4.05-4.15mm With Luer Nut addible</p>

Note :

Scale 1:1

SLIDE CLAMP

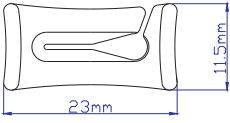
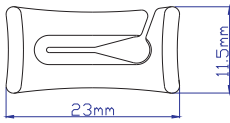
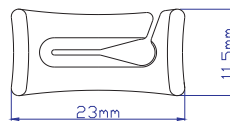
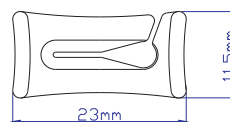
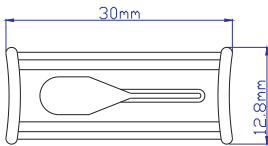
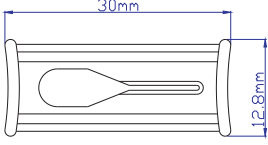
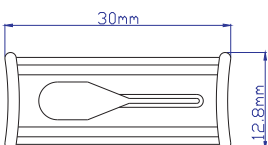
Code	Material	Product Drawing	Product Description
A03009	HDPE		<p>SLIDE CLAMP Size :Small Color :White (Removable)</p>
A03010	HDPE		<p>SLIDE CLAMP Size :Small Color :Blue (Removable)</p>
A03038	ABS		<p>SLIDE CLAMP Size :Small Color :White (Removable)</p>
A03039	HDPE		<p>SLIDE CLAMP Size :Small Color :Yellow (Removable)</p>
A03016	HDPE		<p>SLIDE CLAMP Size :Big Color :Blue (Non-Removable)</p>
A03017	HDPE		<p>SLIDE CLAMP Size :Big Color :White (Non-Removable)</p>
A03014	HDPE		<p>SLIDE CLAMP Size :Big Color :Green (Non-Removable)</p>

Note :

Scale 1:1

SLIDE CLAMP

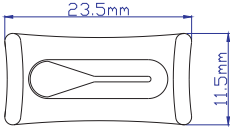
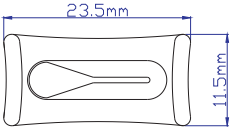
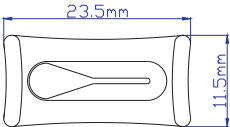
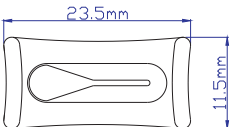
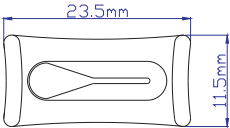
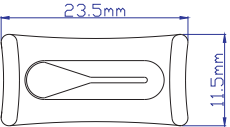
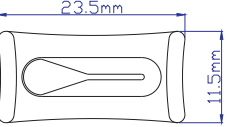
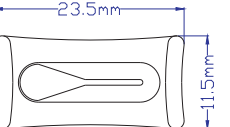
Code	Material	Product Drawing	Product Description
A03018	ABS		<p>SLIDE CLAMP Size :Small Color :White (Non-Removable)</p>
A03040	ABS		<p>SLIDE CLAMP Size :Small Color :Green (Non-Removable)</p>
A03005	HDPE		<p>SLIDE CLAMP Size :Small Color :White (Non-Removable)</p>
A03006	HDPE		<p>SLIDE CLAMP Size :Small Color :Blue (Non-Removable)</p>
A03007	HDPE		<p>SLIDE CLAMP Size :Small Color :Green (Non-Removable)</p>
A03008	HDPE		<p>SLIDE CLAMP Size :Small Color :Yellow (Non-Removable)</p>
A03015	HDPE		<p>SLIDE CLAMP Size :Small Color :Red (Non-Removable)</p>
A03012	HDPE		<p>SLIDE CLAMP Size :Small Color :Light green (Non-Removable)</p>

Note :

Scale 1:1

SLIDE CLAMP

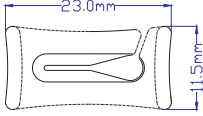
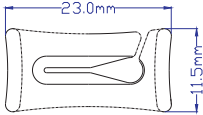
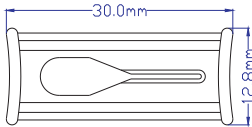
Code	Material	Product Drawing	Product Description
A03041	ABS		<p>SLIDE CLAMP Size :Small Color :Blue (Removable)</p>
A03013	HDPE		<p>SLIDE CLAMP Size :Small Color :Purple (Removable)</p>
A03019	HDPE		<p>SLIDE CLAMP Size :Small Color :Purple (Non-Removable)</p>

Note :

Scale 1:1

PINCH CLAMP

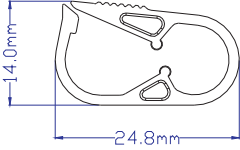
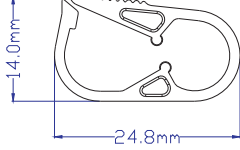
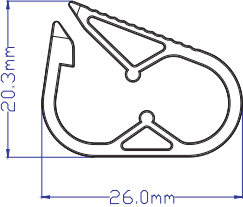
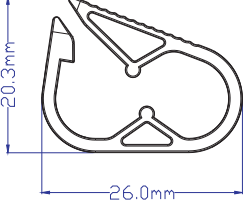
Code	Material	Product Drawing	Product Description
A03023	PP		<p>PINCH CLAMP Size :Small Color :Purple For Tube OD 3.20-3.80mm</p>
A03024	PP		<p>PINCH CLAMP Size :Small Color :Green For Tube OD 3.20-3.80mm</p>
A03025	PP		<p>PINCH CLAMP Size :Small Color :White For Tube OD 2.40-4.10mm</p>
A03027	PP		<p>PINCH CLAMP Size :Small Color :Blue For Tube OD 2.40-4.10mm</p>

Note :

Scale 1:1

MALE LUER LOCK

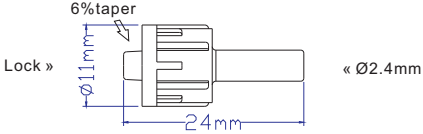
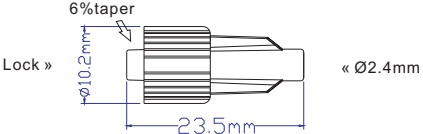
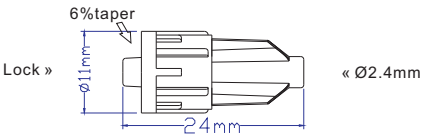
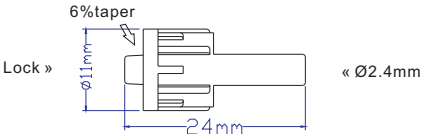
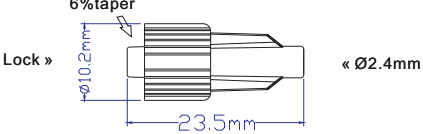
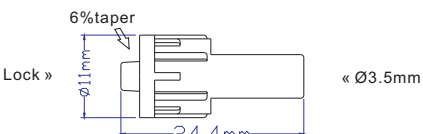
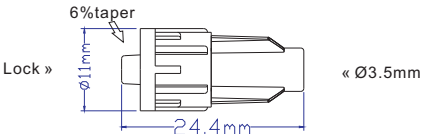
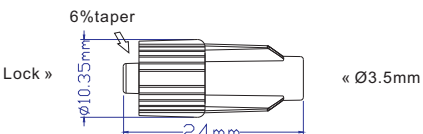
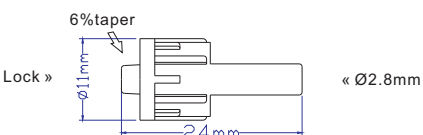
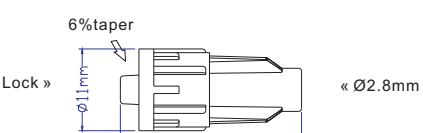
Code	Material	Product Drawing	Product Description
A07032	PVC		<p>MALE LUER LOCK Tubing Pocket :ID 2.4mm Color :Light Blue Tinted For Tube OD 2.35-2.45mm</p>
A07039	ABS		<p>MALE LUER LOCK Tubing Pocket :ID 2.4mm Color :Clear For Tube OD 2.35-2.45mm (W/wing)</p>
A07036	PVC		<p>MALE LUER LOCK Tubing Pocket :ID 2.4mm Color :Blue Tinted For Tube OD 2.35-2.45mm (W/wing)</p>
A07041	PVC		<p>MALE LUER LOCK Tubing Pocket :ID 2.4mm Color :Light Blue Tinted For Tube OD 2.35-2.45mm</p>
A07042	ABS		<p>MALE LUER LOCK Tubing Pocket :ID 2.4mm Color :Clear For Tube OD 2.35-2.45mm (W/wing)</p>
A07035	PVC		<p>MALE LUER LOCK Tubing Pocket :ID 3.5mm Color :Light Blue Tinted For Tube OD 3.45-3.55mm</p>
A07038	PVC		<p>MALE LUER LOCK Tubing Pocket :ID 3.5mm Color :Blue Tinted For Tube OD 3.45-3.55mm (W/wing)</p>
A07077	Polycarbonate		<p>MALE LUER LOCK Tubing Pocket :ID 3.5mm Color :Lavender Tinted For Tube OD 3.45-3.55mm (W/wing)</p>
A07034	PVC		<p>MALE LUER LOCK Tubing Pocket :ID 2.8mm Color :Light Blue Tinted For Tube OD 2.75-2.85mm</p>
A07078	PVC		<p>MALE LUER LOCK Tubing Pocket :ID 2.8mm Color :Blue Tinted For Tube OD 2.75-2.85mm (W/wing)</p>

Note :

Male Luer Lock according to ISO594

Scale 1:1

MALE LUER LOCK

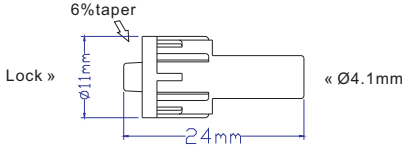
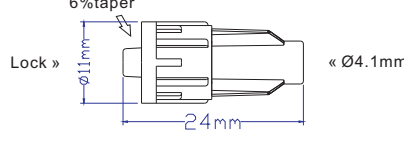
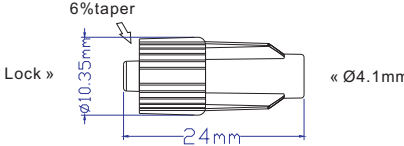
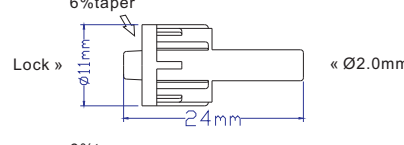
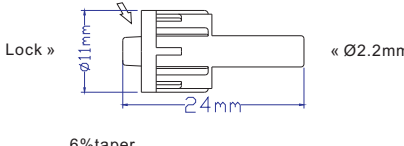
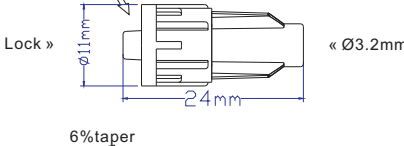
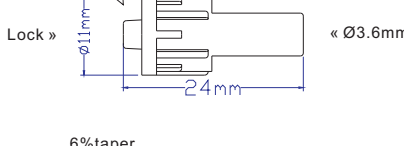
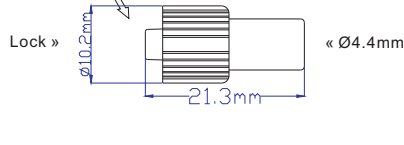
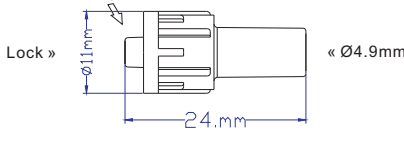
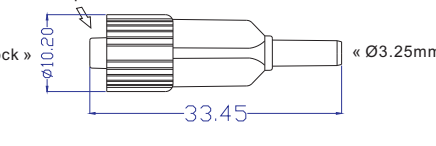
Code	Material	Product Drawing	Product Description
A07033	PVC		<p>MALE LUER LOCK Tubing Pocket :ID 4.1mm Color :Light Blue Tinted For Tube OD 4.05-4.15mm</p>
A07079	PVC		<p>MALE LUER LOCK Tubing Pocket :ID 4.1mm Color :Light Blue Tinted For Tube OD 4.05-4.15mm (W/wing)</p>
A07040	Polycarbonate		<p>MALE LUER LOCK Tubing Pocket :ID 4.1mm Color :Lavender Tinted For Tube OD 4.05-4.15mm (W/wing)</p>
A07080	ABS		<p>MALE LUER LOCK Tubing Pocket :ID 2.0mm Color :Clear For Tube OD 1.95-2.05mm</p>
A07081	PVC		<p>MALE LUER LOCK Tubing Pocket :ID 2.2mm Color :Clear For Tube OD 2.15-2.25mm</p>
A07043	PVC		<p>MALE LUER LOCK Tubing Pocket :ID 3.2mm Color :Light Blue Tinted For Tube OD 3.15-3.25mm (W/wing)</p>
A07082	PVC OR ABS		<p>MALE LUER LOCK Tubing Pocket :ID 3.6mm Color :Blue Tinted or Clear For Tube OD 3.55-3.65mm</p>
A07083	ABS		<p>MALE LUER LOCK Tubing Pocket :ID 4.4mm Color :Clear For Tube OD 4.35-4.45mm</p>
A07084	PVC		<p>MALE LUER LOCK Tubing Pocket :ID 4.9mm Color :Clear For Tube OD 4.85-4.95mm</p>
A07031	ABS		<p>MALE LUER LOCK Tubing Pocket :ID 3.25mm Color :Clear For Tube ID 3.15-3.25mm (W/wing)</p>

Note :

Male Luer Lock according to ISO594

Scale 1:1

MALE LUER LOCK

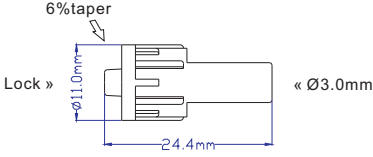
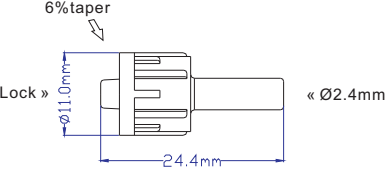
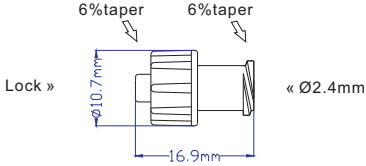
Code	Material	Product Drawing	Product Description
A07085	PVC		<p>MALE LUER LOCK Tubing Pocket :ID 3.0mm Color :Light Blue Tinted For Tube OD 2.95-3.05mm</p>
A07086	PVC		<p>MALE LUER LOCK Tubing Pocket :ID 2.4mm Color :Light Brown Tinted For Tube OD 2.35-2.45mm</p>
A07087	HDPE		<p>MALE/FEMALE LUER LOCK Tubing Pocket :ID 2.4mm Color :Light Blue Tinted For Tube OD 2.35-2.45mm</p>

Note :

Male Luer Lock according to ISO594

Scale 1:1

Y-CONNECTOR

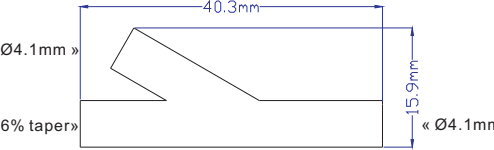
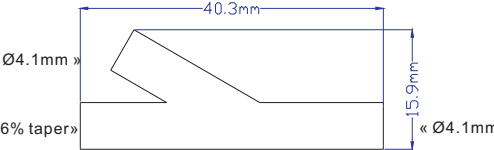
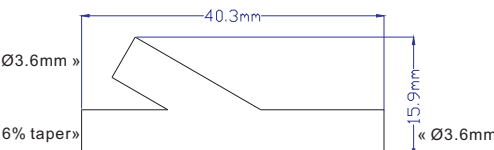
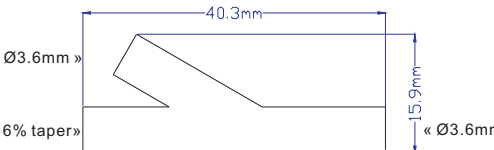
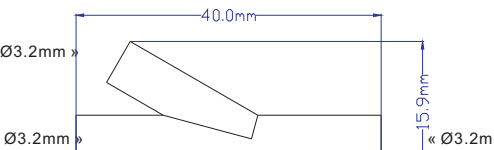
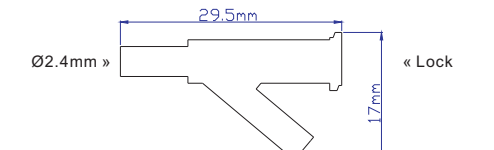
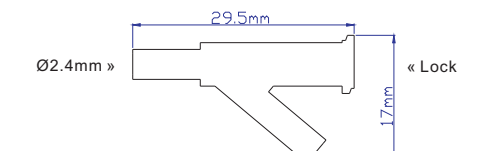
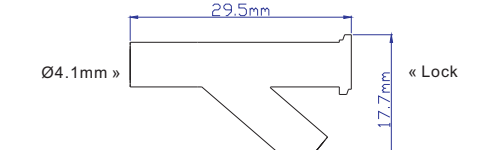
Code	Material	Product Drawing	Product Description
A04019	ABS		<p>Y-CONNECTOR Tubing Pocket :ID 4.1mm Color :Clear For Tube OD 4.05-4.15mm</p>
A04052	PVC		<p>Y-CONNECTOR Tubing Pocket :ID 4.1mm Color :Light Blue Tinted For Tube OD 4.05-4.15mm</p>
A04023	PVC		<p>Y-CONNECTOR Tubing Pocket :ID 3.6mm Color :Light Blue Tinted For Tube OD 3.55-3.65mm</p>
A04053	ABS		<p>Y-CONNECTOR Tubing Pocket :ID 3.6mm Color :Clear For Tube OD 3.55-3.65mm</p>
A04031	ABS		<p>Y-CONNECTOR Tubing Pocket :ID 3.6mm Color :Clear For Tube OD 3.55-3.65mm</p>
A04018	ABS		<p>Y-CONNECTOR Tubing Pocket :ID 2.4mm Color :Clear For Tube OD 2.35-2.45mm (W/Female Adapter)</p>
A04021	PVC		<p>Y-CONNECTOR Tubing Pocket :ID 2.4mm Color :Light Blue Tinted For Tube OD 2.35-2.45mm (W/Female Adapter)</p>
A04022	ABS		<p>Y-CONNECTOR Tubing Pocket :ID 3.5mm Color :Clear For Tube OD 3.45-3.55mm (W/Female Adapter)</p>

Note :

Scale 1:1

Y-CONNECTOR

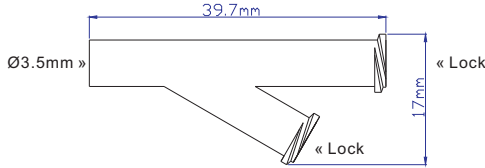
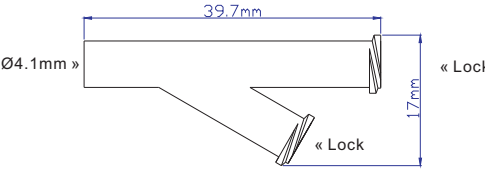
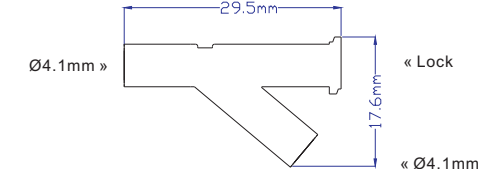
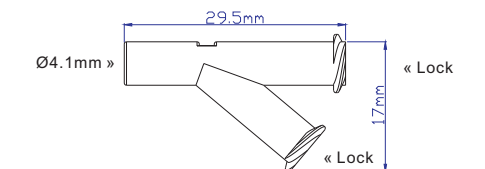
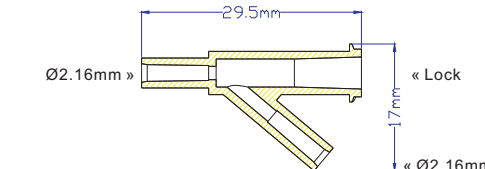
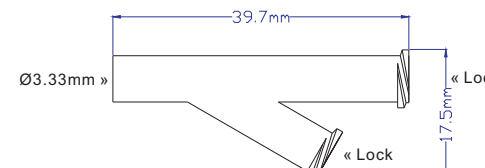
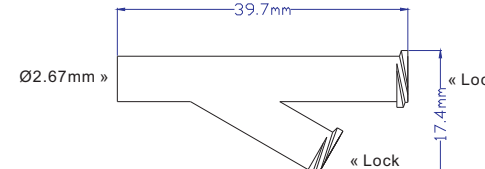
Code	Material	Product Drawing	Product Description
A04054	PVC		<p>Y-CONNECTOR Tubing Pocket :ID 3.5mm Color :Clear For Tube OD 3.45-3.55mm W/Double Female adapter</p>
A04017	PVC		<p>Y-CONNECTOR Tubing Pocket :ID 4.1mm Color :Light Blue Tinted For Tube OD 4.05-4.15mm W/Double Female adapter (A TYPE)</p>
A04020	PVC		<p>Y-CONNECTOR Tubing Pocket :ID 4.1mm Color :Light Blue Adapter For Tube OD 4.05-4.15mm (W/Female Adapter)</p>
A04024	PVC		<p>Y-CONNECTOR Tubing Pocket :ID 4.1mm Color :Light Blue Tinted For Tube OD 4.05-4.15mm W/Double Female adapter (B TYPE)</p>
A04042	ABS		<p>Y-CONNECTOR Tubing Pocket :ID 2.16mm Color :Clear For Tube OD 2.11-2.21mm W/Female adapter</p>
A04055	PVC		<p>Y-CONNECTOR Tubing Pocket :ID 3.33mm Color :White For Tube OD 3.28-3.38mm W/Double Female adapter</p>
A04026	PVC		<p>Y-CONNECTOR Tubing Pocket :ID 2.67mm Color :white For Tube OD 2.62-2.72mm W/Double Female adapter</p>

Note :

Scale 1:1

Y-CONNECTOR

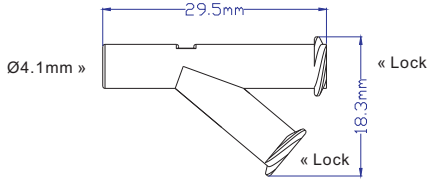
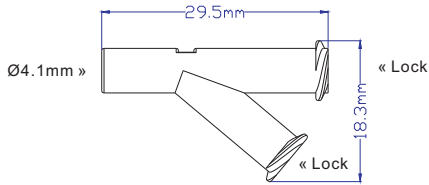
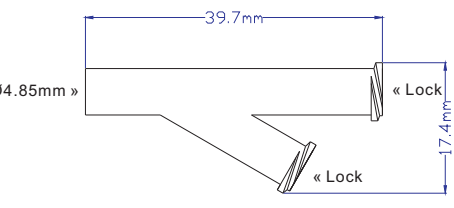
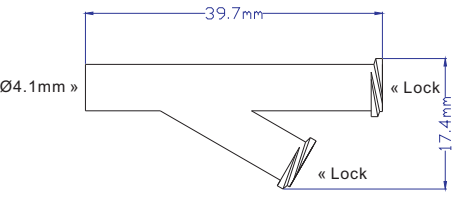
Code	Material	Product Drawing	Product Description
A04027	PVC		<p>Y-CONNECTOR Tubing Pocket :ID 4.1mm Color :Clear For Tube OD 4.05-4.15mm W/Double Female adapter (B TYPE)</p>
A04028	PVC		<p>Y-CONNECTOR Tubing Pocket :ID 4.3mm Color :Clear For Tube OD 4.25-4.35mm W/Double Female adapter (B TYPE)</p>
A04029	PVC		<p>Y-CONNECTOR Tubing Pocket :ID 4.85mm Color :Light Blue Tinted For Tube OD 4.80-4.90mm W/Double Female adapter</p>
A04030	PVC		<p>Y-CONNECTOR Tubing Pocket :ID 4.1mm Color :Clear For Tube OD 4.05-4.15mm W/Double Female adapter</p>

Note :

Scale 1:1

MALE SLIP

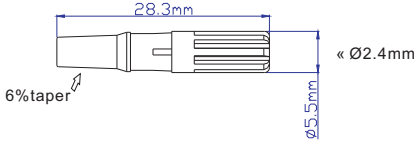
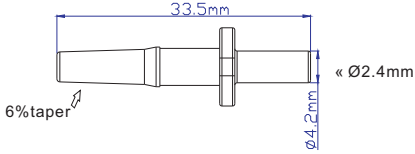
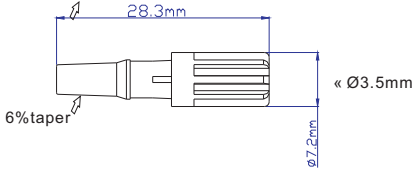
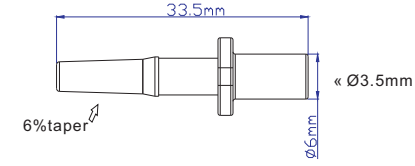
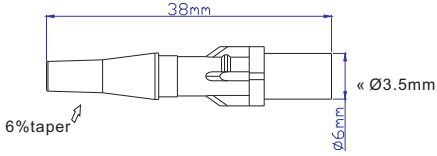
Code	Material	Product Drawing	Product Description
A07044	PVC		<p>MALE SLIP Tubing Pocket :2.4mm Color :Light Blue Tinted For Tube OD 2.35-2.45mm (A TYPE)</p>
A07047	PVC		<p>MALE SLIP Tubing Pocket :2.4mm Color :Light Blue Tinted For Tube OD 2.35-2.45mm (B TYPE)</p>
A07046	PVC		<p>MALE SLIP Tubing Pocket :3.5mm Color :Light Blue Tinted For Tube OD 3.45-3.55mm (A TYPE)</p>
A07050	PVC		<p>MALE SLIP Tubing Pocket :3.5mm Color :Light Blue Tinted For Tube OD 3.45-3.55mm (B TYPE)</p>
A07049	ABS		<p>MALE SLIP Tubing Pocket :3.5mm Color :Light Blue Tinted For Tube OD 3.45-3.55mm (C TYPE)</p>

Note :

Scale 1:1

MALE SLIP

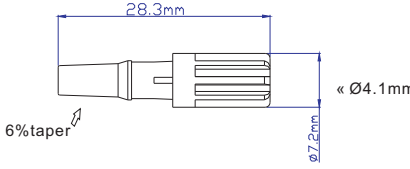
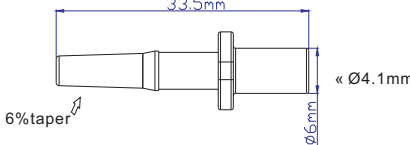
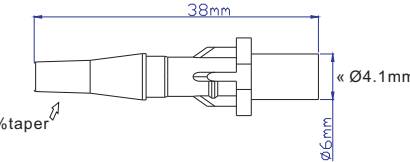
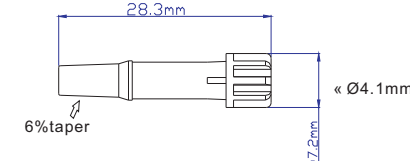
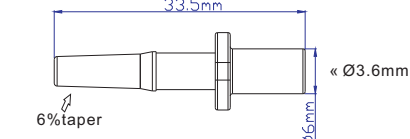
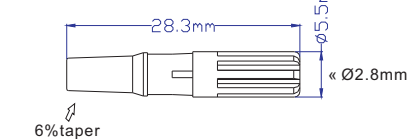
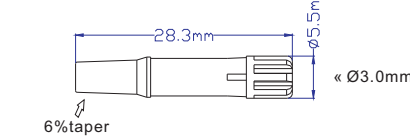
Code	Material	Product Drawing	Product Description
A07045	PVC		<p>MALE SLIP Tubing Pocket :4.1mm Color :Light Blue Tinted For Tube OD 4.05-4.15mm (A TYPE)</p>
A07051	PVC		<p>MALE SLIP Tubing Pocket :4.1mm Color :Light Blue Tinted For Tube OD 4.05-4.15mm (B TYPE)</p>
A07048	ABS		<p>MALE SLIP Tubing Pocket :4.1mm Color :Clear For Tube OD 4.05-4.15mm (C TYPE)</p>
A07053	PVC		<p>MALE SLIP Tubing Pocket :4.1mm Color :Light Blue Tinted For Tube OD 4.05-4.15mm (D TYPE)</p>
A07088	PVC		<p>MALE SLIP Tubing Pocket :3.6mm Color :Light Blue Tinted For Tube OD 3.55-3.65mm</p>
A07076	PVC		<p>MALE SLIP Tubing Pocket :2.8mm Color :Clear For Tube OD 2.75-2.85mm</p>
A07054	PVC		<p>MALE SLIP Tubing Pocket :3.0mm Color :Clear For Tube OD 2.95-3.05mm (D TYPE)</p>

Note :

Scale 1:1

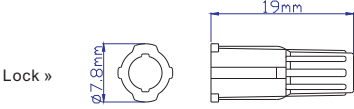
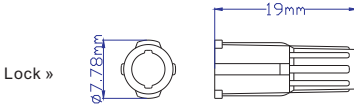
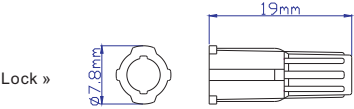
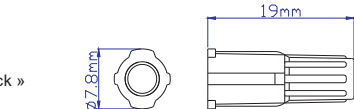
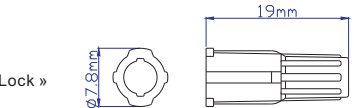
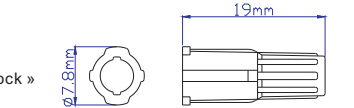
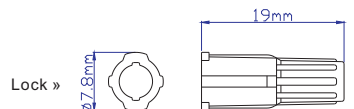

MALE SLIP CAP

Code	Material	Product Drawing	Product Description
A01025	LDPE	Lock » 	MALE SLIP CAP Pocket :4.5mm Color :White For T & MLL (Vented)
A01026	LDPE	Lock » 	MALE SLIP CAP Pocket :4.3mm Color :White For T & MLL (Vented)
A01027	HDPE	Lock » 	MALE SLIP CAP Pocket :4.5mm Color :Blue For T & MLL (Vented)
A01029	HDPE	Lock » 	MALE SLIP CAP Pocket : 6% Taper Color :Blue (Non-Vented)
A01030	PP	Lock » 	MALE SLIP CAP Pocket :4.5mm Color :Nature For T & MLL (Vented)
A01032	LDPE	Lock » 	MALE SLIP CAP Pocket :4.5mm Color :Nature For T & MLL (Vented)
A01043	LDPE	Lock » 	MALE SLIP CAP Pocket :4.5mm Color :Yellow For T & MLL (Vented)

Note :

Scale 1:1

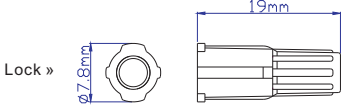
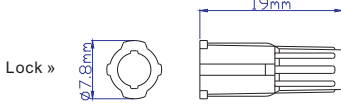
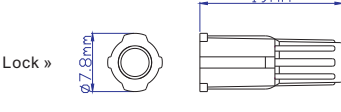
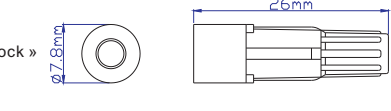
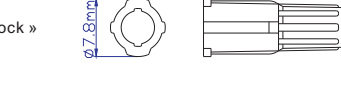
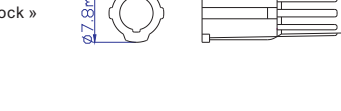
MALE SLIP CAP

Code	Material	Product Drawing	Product Description
A01034	PP		<p>MALE SLIP CAP Pocket : 6% Taper Color :Nature (Non-Vented)</p>
A01028	HDPE		<p>MALE SLIP CAP Pocket : 6% Taper Color :Blue (Vented)</p>
A01033	LDPE		<p>MALE SLIP CAP For Enteral Pocket :ID 4.9mm Color :Nature (Non-Vented)</p>
A01044	LDPE		<p>MALE SLIP CAP For Mini Spike Color :White (Non-Vented)</p>
A01035	LDPE		<p>MALE SLIP CAP Pocket : 6% Taper Color :Red (Vented)</p>
A01045	PP		<p>MALE SLIP CAP For Mini Spike Color :Nature (Vented)</p>
A01031	LDPE		<p>ENTRAL SYRINGE CAP Color :Orange (Non-Vented)</p>
A01042	LDPE		<p>ENTRAL SYRINGE CAP Color :Orange (Vented)</p>

Note :

Scale 1:1

FEMALE LUER LOCK

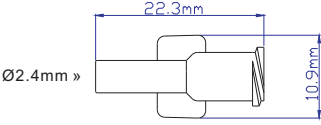
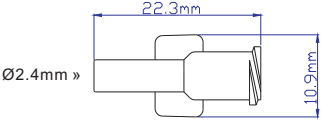
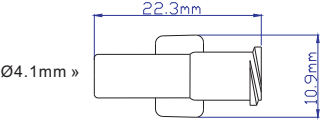
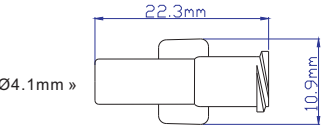
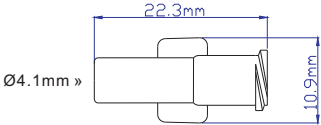
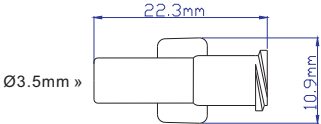
Code	Material	Product Drawing	Product Description
A07015	PVC	 <p>« Lock</p>	<p>FEMALE LUER LOCK Tube Pocket : 2.4mm Color :Light Blue Tinted For Tube OD 2.35-2.45mm</p>
A07020	PVC	 <p>« Lock</p>	<p>FEMALE LUER LOCK Tube Pocket : 2.4mm Color :Blue Tinted For Tube OD 2.35-2.45mm</p>
A07018	PVC	 <p>« Lock</p>	<p>FEMALE LUER LOCK Tube Pocket : 4.1mm Color :Light Blue Tinted For Tube OD 4.05-4.15mm</p>
A07021	PVC	 <p>« Lock</p>	<p>FEMALE LUER LOCK Tube Pocket : 4.1mm Color : Blue Tinted For Tube OD 4.05-4.15mm</p>
A07022	Polycarbonate	 <p>« Lock</p>	<p>FEMALE LUER LOCK Tube Pocket : 4.1mm Color :Lavender Tinted For Tube OD 4.05-4.15mm</p>
A07017	PVC	 <p>« Lock</p>	<p>FEMALE LUER LOCK Tube Pocket : 3.5mm Color :Light Blue Tinted For Tube OD 3.45-3.55mm</p>

Note :

Female Luer Lock according to ISO594

Scale 1:1

FEMALE LUER LOCK

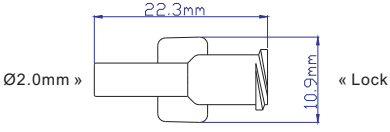
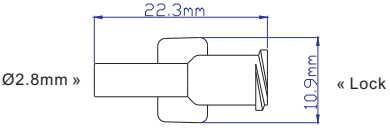
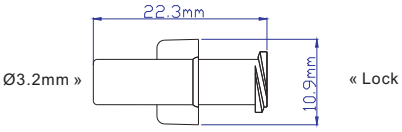
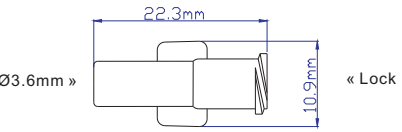
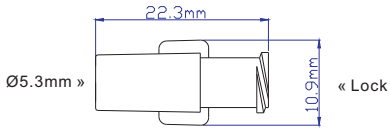
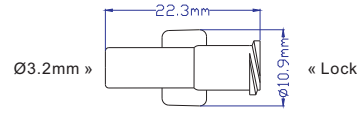
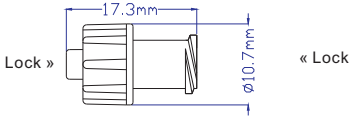
Code	Material	Product Drawing	Product Description
A07019	PVC		<p>FEMALE LUER LOCK Tube Pocket : 2.0mm Color :Light Blue Tinted For Tube OD 1.95-2.05mm</p>
A07016	PVC		<p>FEMALE LUER LOCK Tube Pocket : 2.8mm Color :Light Blue Tinted For Tube OD 2.75-2.85mm</p>
A07089	PVC		<p>FEMALE LUER LOCK Tube Pocket : 3.2mm Color :Light Blue Tinted For Tube OD 3.15-3.25mm</p>
A07090	PVC		<p>FEMALE LUER LOCK Tube Pocket : 3.6mm Color : Light Blue Tinted For Tube OD 3.55-3.65mm</p>
A07023	PVC		<p>FEMALE LUER LOCK Tube Pocket : 5.3mm Color :Light Blue Tinted For Tube OD 5.25-5.35mm</p>
A07091	PVC		<p>FEMALE LUER LOCK Tube Pocket : 3.2mm Color :Light Blue Tinted For Tube OD 3.15-3.25mm</p>
A01036	Polycarbonate		<p>Double DeadEnd W/0.106" ID Pocket Fit Male End, Color :Lavender Tinted</p>

Note :

Female Luer Lock according to ISO594

Scale 1:1

FEMALE LUER LOCK

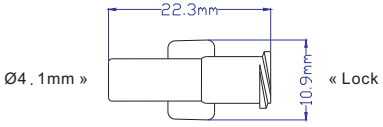
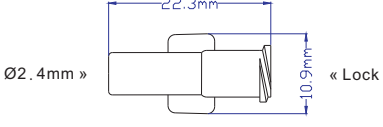
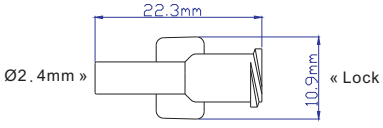
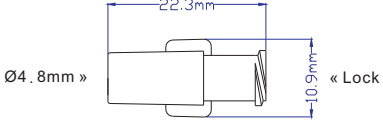
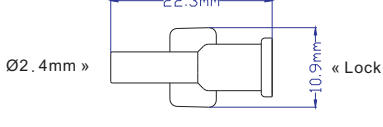
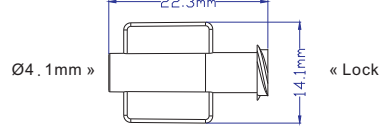
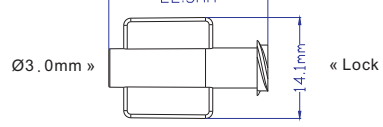
Code	Material	Product Drawing	Product Description
A07092	PVC		<p>FEMALE LUER LOCK Tube Pocket : 4.1mm Color :Clear For Tube OD 4.05-4.15mm</p>
A07093	PVC		<p>FEMALE LUER LOCK Tube Pocket : 2.4mm Color :Clear For Tube OD 2.35-2.45mm</p>
A07025	PVC		<p>FEMALE LUER LOCK Tube Pocket : 2.4mm Color :Light Brown Tinted For Tube OD 2.35-2.45mm</p>
A07024	PVC		<p>FEMALE LUER LOCK Tube Pocket : 4.8mm Color :Clear For Tube OD 4.75-4.85mm</p>
A07094	PVC		<p>Feeding FLL ID 2.4mm Tube Pocket : 2.4mm Color :Orange For Tube OD 2.35-2.45mm</p>
A03039	PVC		<p>FEMALE LUER LOCK Tube Pocket : 4.1mm Color :Light Blue Tinted For Tube OD 4.05-4.15mm</p>
A07029	PVC		<p>FEMALE LUER LOCK Tube Pocket : 3.0mm Color :Light Blue Tinted For Tube OD 2.95-3.05mm</p>

Note :

Female Luer Lock according to ISO594

Scale 1:1

FEMALE LUER LOCK

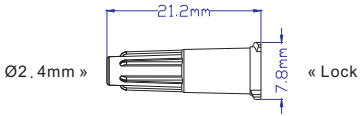
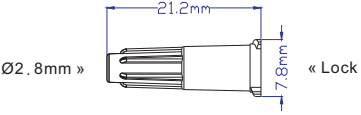
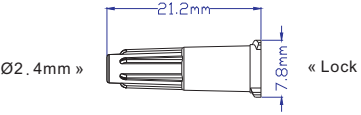
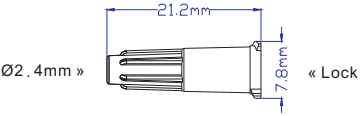
Code	Material	Product Drawing	Product Description
A07095	PVC		<p>FEMALE LUER LOCK Tube Pocket : 2.4mm Color :Light Blue Tinted For Tube OD 2.35-2.45mm (B TYPE)</p>
A07026	PVC		<p>FEMALE LUER LOCK Tube Pocket : 2.8mm Color :Yellow For Tube OD 2.75-2.85mm (B TYPE)</p>
A07027	PVC		<p>FEMALE LUER LOCK Tube Pocket : 2.4mm Color :Yellow For Tube OD 2.35-2.45mm</p>
A07028	PVC		<p>Feeding FLL ID 2.4mm Tube Pocket : 2.4mm Color :Gray For Tube OD 2.35-2.45mm</p>

Note :

Female Luer Lock according to ISO594

Scale 1:1

FEMALE LUER LOCK CAP

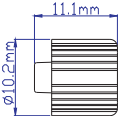
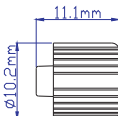
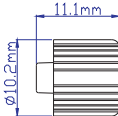
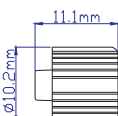
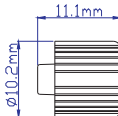
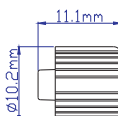
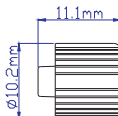
Code	Material	Product Drawing	Product Description
A01012	HDPE	Lock » 	FEMALE LUER LOCK CAP Color :Blue Non-Vented
A01013	HDPE	Lock » 	FEMALE LUER LOCK CAP Color :Nature Non-Vented
A01016	HDPE	Lock » 	FEMALE LUER LOCK CAP Color :White Non-Vented
A01017	Polycarbonate	Lock » 	FEMALE LUER LOCK CAP Color :Clear Non-Vented
A01018	HDPE	Lock » 	FEMALE LUER LOCK CAP Color :Green Non-Vented
A01019	HDPE	Lock » 	FEMALE LUER LOCK CAP Color :Red Non-Vented
A01046	HDPE	Lock » 	FEMALE LUER LOCK CAP Color :White Vented

Note :

Scale 1:1

FEMALE LUER LOCK CAP

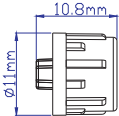
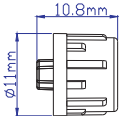
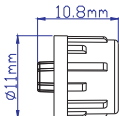
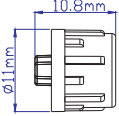
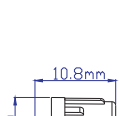
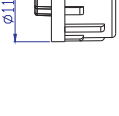
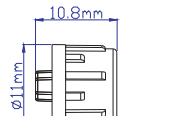
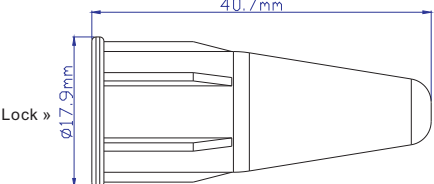
Code	Material	Product Drawing	Product Description
A01014	HDPE	Lock » 	FEMALE LUER LOCK CAP Color :Green Vented
A01015	HDPE	Lock » 	FEMALE LUER LOCK CAP Color :Red Vented
A01020	HDPE	Lock » 	FEMALE LUER LOCK CAP Color :White Vented
A01022	LDPE	Lock » 	FEMALE LUER LOCK CAP Color :Nature Vented
A01021	LDPE	Lock » 	FEMALE LUER LOCK CAP Color :Nature Vented
A01023	HDPE	Lock » 	FEMALE LUER LOCK CAP Color :Blue Vented
A01024	LDPE	Lock » 	CAP FOR MINI SPIKE Color :Nature
A01047	LDPE	Lock » 	ENTERAL CAP Color :Nature

Note :

Scale 1:1

CONNECTOR FOR HEAR LUNG TUBING SET

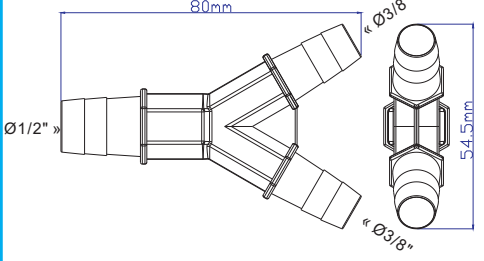
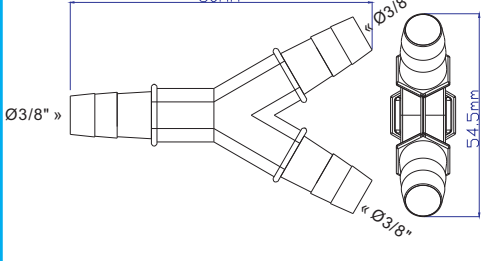
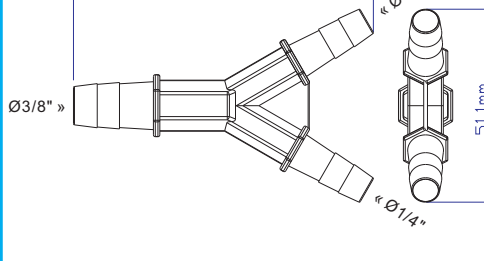
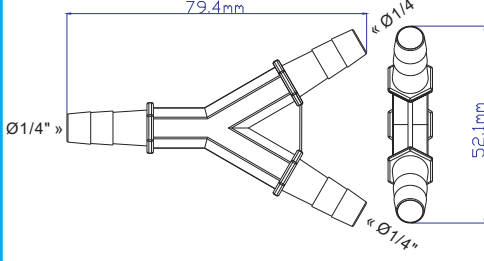
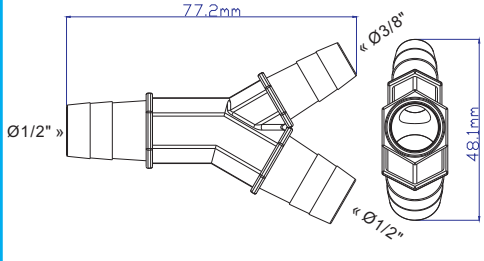
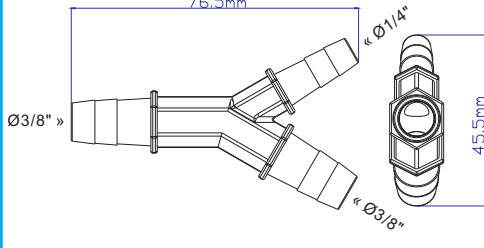
Code	Material	Product Drawing	Product Description
A04056	Polycarbonate		<p>Y-CONNECTOER Color :Clear Tubing pocket:3/8"*3/8"*1/2"</p>
A04057	Polycarbonate		<p>Y-CONNECTOER Color :Clear Tubing pocket:3/8"*3/8"*3/8"</p>
A04059	Polycarbonate		<p>Y-CONNECTOER Color :Clear Tubing pocket:1/4"*1/4"*3/8"</p>
A04059	Polycarbonate		<p>Y-CONNECTOER Color :Clear Tubing pocket:1/4"*1/4"*1/4"</p>
A04060	Polycarbonate		<p>Y-CONNECTOER Color :Clear Tubing pocket:3/8"*1/2"*1/2"</p>
A04043	Polycarbonate		<p>Y-CONNECTOER Color :Clear Tubing pocket:1/4"*3/8"*3/8"</p>

Note :

Scale 1:2

CONNECTOR FOR HEAR LUNG TUBING SET

Code	Material	Product Drawing	Product Description
A04061	Polycarbonate		<p>Y-LLF CONNECTOER Color :Clear Tubing pocket:3/8"*3/8"*3/8" With Luer Lock</p>
A04062	Polycarbonate		<p>Y-LLF CONNECTOER Color :Clear Tubing pocket:1/4"*1/4"*1/4" With Luer Lock</p>
A04063	Polycarbonate		<p>Y-LLF CONNECTOER Color :Clear Tubing pocket:3/8"*3/8"*1/2" With Luer Lock</p>
A04064	Polycarbonate		<p>Y-LLF CONNECTOER Color :Clear Tubing pocket:3/8"*1/2"*1/2" With Luer Lock</p>
A04065	Polycarbonate		<p>STRAIGHT-CONNECTOER Color :Clear Tubing pocket:1/2"*3/8" With Luer Lock</p>
A04066	Polycarbonate		<p>STRAIGHT-CONNECTOER Color :Clear Tubing pocket:3/8"*3/8" With Luer Lock</p>

Note :

Scale 1:2

CONNECTOR FOR HEAR LUNG TUBING SET

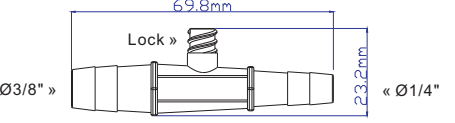
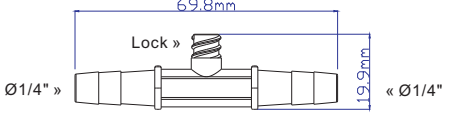
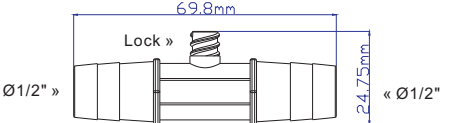
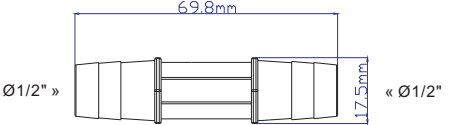
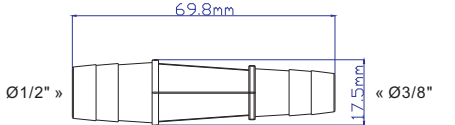
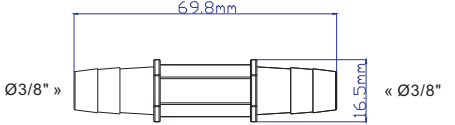
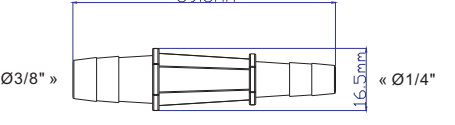
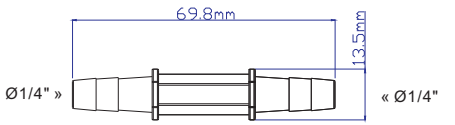
Code	Material	Product Drawing	Product Description
A04067	Polycarbonate		<p>STRAIGHT-CONNECTOER Color :Clear Tubing pocket: 1/4"*3/8" With Luer Lock</p>
A04068	Polycarbonate		<p>STRAIGHT-CONNECTOER Color :Clear Tubing pocket: 1/4"*1/4" With Luer Lock</p>
A04069	Polycarbonate		<p>STRAIGHT-CONNECTOER Color :Clear Tubing pocket: 1/2"*1/2" With Luer Lock</p>
A04070	Polycarbonate		<p>STRAIGHT-CONNECTOER Color :Clear Tubing pocket: 1/2"*1/2"</p>
A04071	Polycarbonate		<p>STRAIGHT-CONNECTOER Color :Clear Tubing pocket: 1/2"*3/8"</p>
A04072	Polycarbonate		<p>STRAIGHT-CONNECTOER Color :Clear Tubing pocket: 3/8"*3/8"</p>
A04073	Polycarbonate		<p>STRAIGHT-CONNECTOER Color :Clear Tubing pocket: 1/4"*3/8"</p>
A04074	Polycarbonate		<p>STRAIGHT-CONNECTOER Color :Clear Tubing pocket: 1/4"*1/4"</p>

Note :

Scale 1:2

CONNECTOR FOR HEAR LUNG TUBING SET

Code	Material	Product Drawing	Product Description
A04075	Polycarbonate		<p>Y-LLF CONNECTOER Color :Clear Tubing pocket:3/16"*3/16"*3/16" With Luer Lock</p>
A04076	Polycarbonate		<p>Y-CONNECTOER Color :Clear Tubing pocket:3/16"*3/16"*3/16"</p>
A04077	Polycarbonate		<p>Y-LLF CONNECTOER Color :Clear Tubing pocket:1/4"*3/16" With Luer Lock</p>
A04078	Polycarbonate		<p>Y-LLF CONNECTOER Color :Clear Tubing pocket:3/16"*3/16" With Luer Lock</p>
A04079	Polycarbonate		<p>STRAIGHT-CONNECTOER Color :Clear Tubing pocket:1/4"*1/8"</p>
A04080	Polycarbonate		<p>STRAIGHT-CONNECTOER Color :Clear Tubing pocket:1/8"*1/8"</p>

Note :

Scale 1:2

CONNECTOR FOR HEAR LUNG TUBING SET

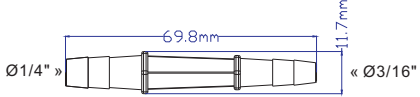
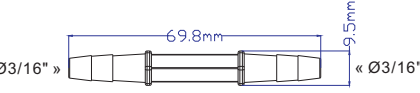
Code	Material	Product Drawing	Product Description
A04081	Polycarbonate		<p>STRAIGHT-CONNECTOER Color :Clear Tubing pocket:1/4"*3/16"</p>
A04082	Polycarbonate		<p>STRAIGHT-CONNECTOER Color :Clear Tubing pocket:3/16"*3/16"</p>

Note :

Scale 1:2

BIFURCATION PORT

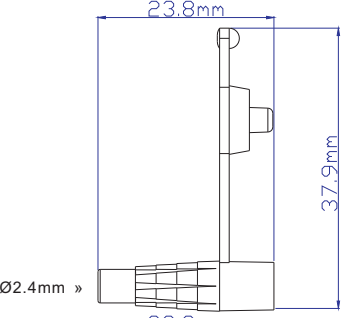
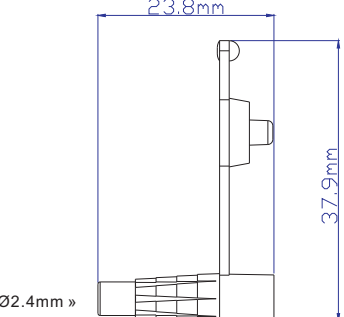
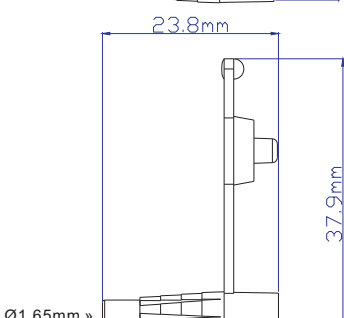
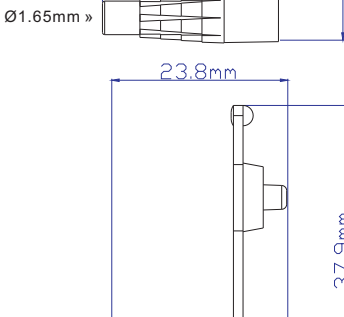
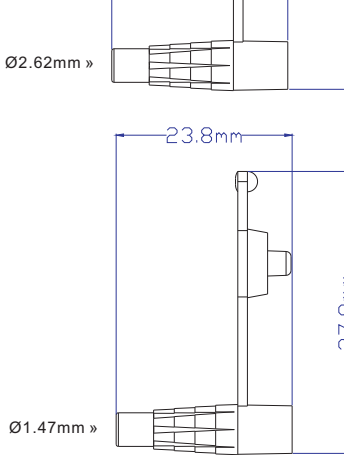
Code	Material	Product Drawing	Product Description
E16078	PVC		<p>BIFURCATION PORT Color :Light Blue Tinted Tubing pocket:2.4mm</p>
E16079	PVC		<p>BIFURCATION PORT Color :Orange Tubing pocket:2.4mm</p>
E16080	PVC		<p>BIFURCATION PORT Color :Orange Tubing pocket:1.65mm (5Fr)</p>
E16081	PVC		<p>BIFURCATION PORT Color :Orange Tubing pocket:2.62mm (8Fr)</p>
E16082	PVC		<p>BIFURCATION PORT Color :Orange Tubing pocket:1.47mm (4Fr)</p>

Note :

Scale 1:1

BIFURCATION PORT

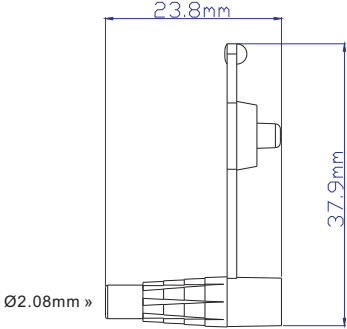
Code	Material	Product Drawing	Product Description
E16083	PVC		<p>BIFURCATION PORT Color :Orange Tubing pocket:2.08mm (6.5Fr)</p>

Note :

Scale 1:1

SPIKE

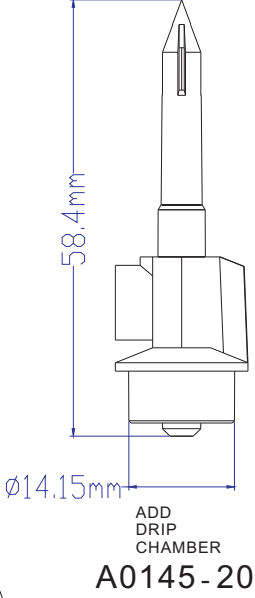
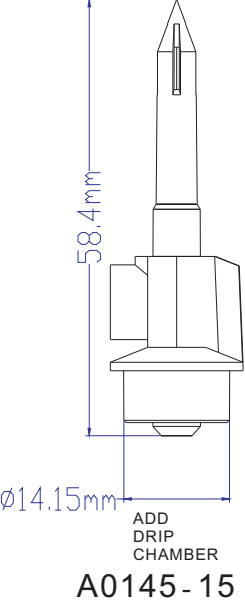
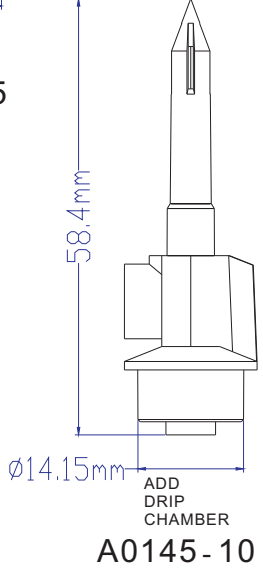
Code	Material	Product Drawing	Product Description
A08007	ABS		<p>Universal Spike Color :White 20 drops,Vented</p>
A08008	ABS		<p>Universal Spike Color :White 15 drops,Vented</p>
A08009	ABS		<p>Universal Spike Color :White 10 drops,Vented</p>

Note :

Scale 1:1

SPIKE

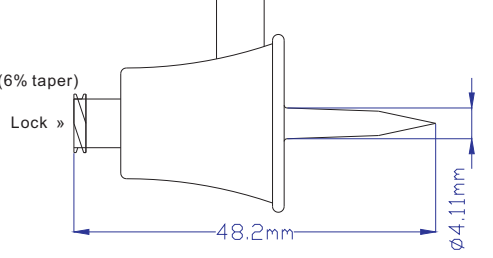
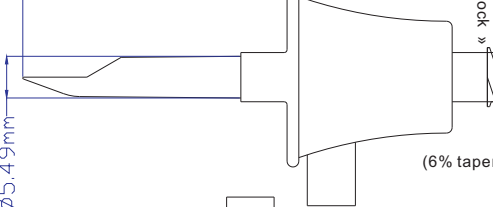
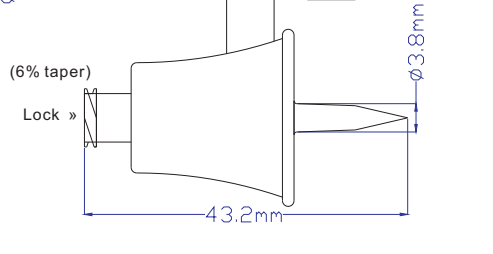
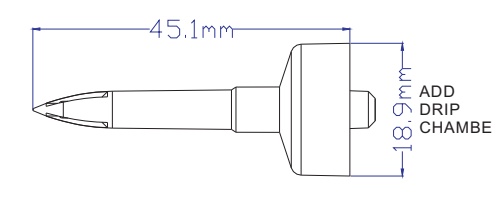
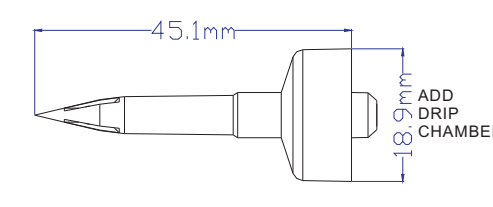
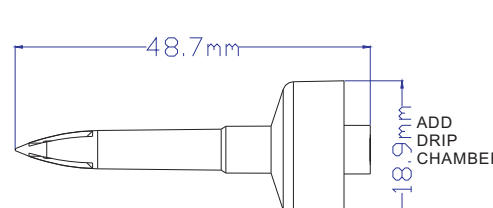
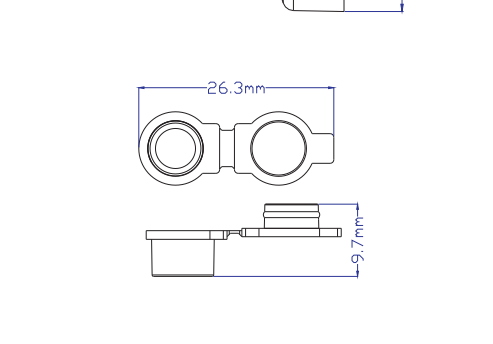
Code	Material	Product Drawing	Product Description
A08010	ABS		<p>MINI SPIKE Color :White With Female 6% taper</p>
A08011	ABS		<p>LARGE SPIKE Color :White With Female 6% taper</p>
A08012	ABS		<p>MINI MINI SPIKE Color :White With Female 6% taper</p>
A08013	ABS		<p>R-SPIKE Color :White 20DP</p>
A08014	ABS		<p>R-SPIKE Color :White 15DP</p>
A08015	ABS		<p>R-SPIKE Color :White 10DP</p>
A08016	PVC		<p>VENTED-CAP FOR SPIKE Color :Light Blue Vented</p>

Note :

Scale 1:1

SPIKE

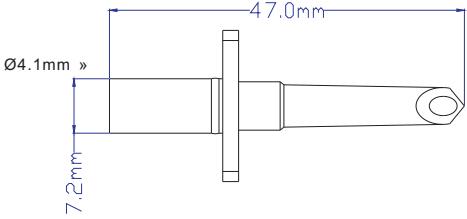
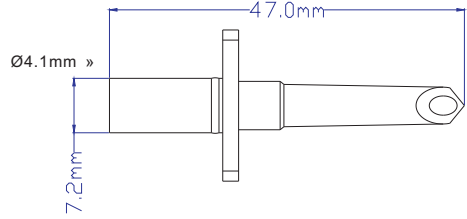
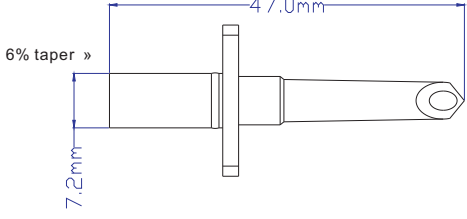
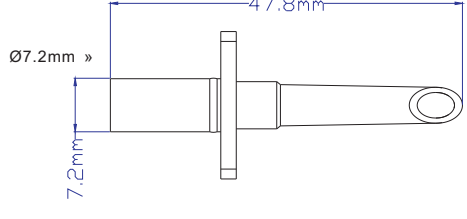
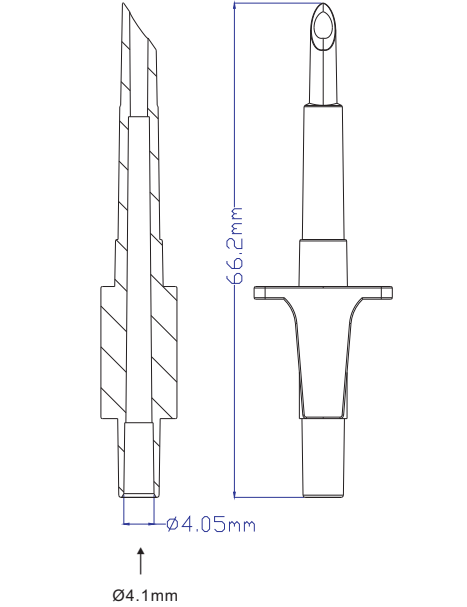
Code	Material	Product Drawing	Product Description
A08017	ABS		<p>NON-VENTED SPIKE Color :Clear For Tube OD4.05-4.15 mm</p>
A08018	ABS		<p>NON-VENTED SPIKE Color :White For Tube OD4.05-4.15 mm</p>
A08006	Nylon		<p>NON-VENTED SPIKE Color :Nature W/Female 6% taper</p>
A08019	ABS		<p>NON-VENTED SPIKE Color :White A-Type with Large Hole For Tube ID7.2 mm</p>
A08001	ABS		<p>NON-VENTED SPIKE Color :White A-Type For Tube OD4.05-4.15 mm</p>

Note :

Scale 1:1

SPIKE

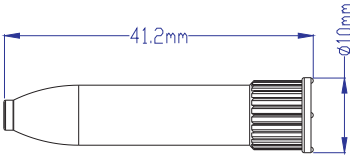
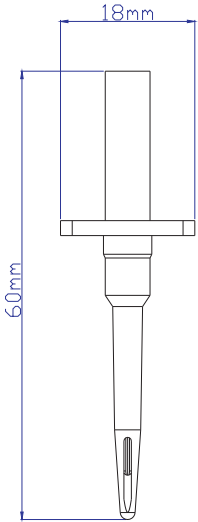
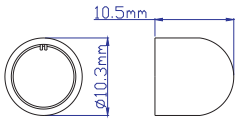
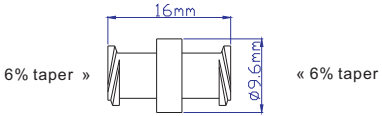
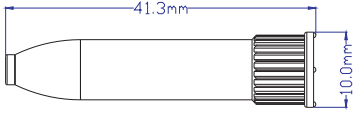
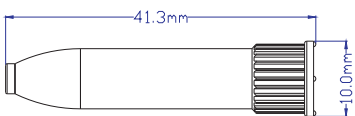
Code	Material	Product Drawing	Product Description
A08021	LDPE		<p>VENTED SPIKE CAP Color :Nature Large</p>
A08022	ABS		<p>SAMPLING SPIKE Color :White For Tube OD4.05-4.15 mm</p>
A08023	PP		<p>SAMPLING SPIKE COVER Color :Nature</p>
A08024	PP		<p>DOUBLE FEMALE LUER LOCK Color :Nature</p>
A08025	PP		<p>VENTED SPIKE CAP Color :Nature Large Gamma resistant</p>
A08026	PP		<p>VENTED SPIKE CAP Color :Nature Large</p>

Note :

Scale 1:1

LUER NUT

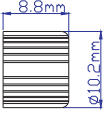
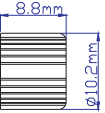
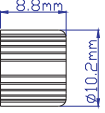
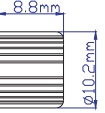
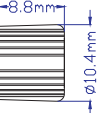
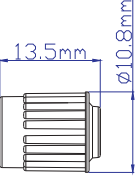
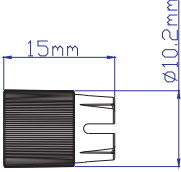
Code	Material	Product Drawing	Product Description
A07009	ABS		<p>LUER NUT Color :Clear</p>
A07010	Polycarbonate		<p>LUER NUT Color :Clear</p>
A07013	ABS		<p>LUER NUT Color :White</p>
A07096	ABS		<p>LUER NUT Color :Blue</p>
A07014	Polycarbonate		<p>LUER NUT Color :Nature</p>
A07011	ABS		<p>LUER NUT Color :Clear B TYPE</p>
A07012	ABS		<p>LUER NUT Color :Clear C TYPE</p>

Note :

Scale 1:1

OTHER PARTS

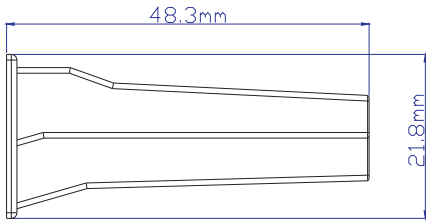
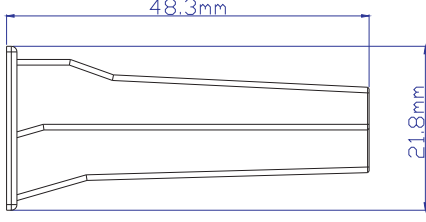
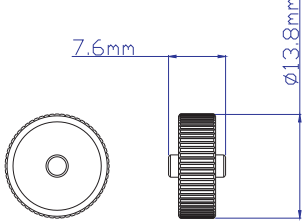
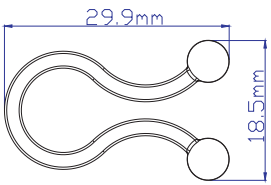
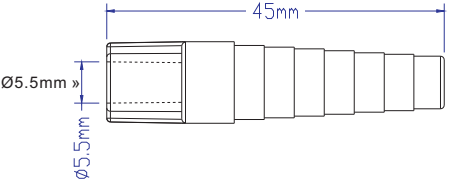
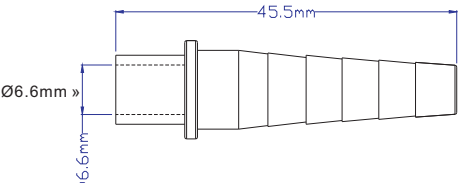
Code	Material	Product Drawing	Product Description
A03042	ABS		<p>ROLLER CLAMP -Outside Crust Color :White</p>
A03043	ABS		<p>ROLLER CLAMP -Outside Crust Color :Red</p>
A03044	ABS		<p>ROLLER CLAMP -Wheel Color :White</p>
A03020	Nylon		<p>TWIST CLIPS Color :White ID 12.7mm</p>
A04083	PVC		<p>STEP CONNECTOR Color :Light Blue Tinted Tubing Pocket :ID 5.5mm</p>
A04084	PVC		<p>STEP CONNECTOR Color :Light Blue Tinted Tubing Pocket :ID 6.6mm</p>

Note :

Scale 1:1

OTHER PARTS

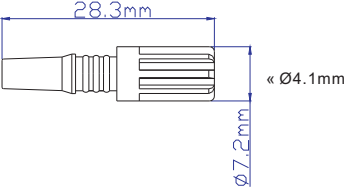
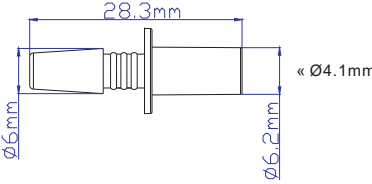
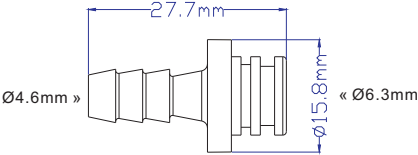
Code	Material	Product Drawing	Product Description
A04039	PVC		<p>SILICONE TUBE CONNECTOR Color :Light Blue Tinted Tubing Pocket :ID 4.1mm A TYPE</p>
A04040	PVC		<p>SILICONE TUBE CONNECTOR Color :Light Blue Tinted Tubing Pocket :ID 4.1mm B TYPE</p>
A04085	POM		<p>Quick connector Color :Nature Tubing Pocket :ID 6.3mm</p>

Note :

Scale 1:1

DRIP CHAMBER

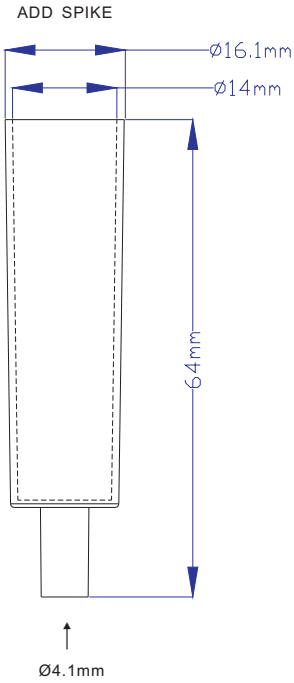
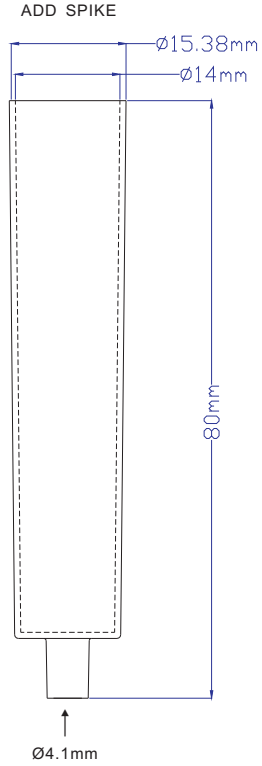
Code	Material	Product Drawing	Product Description
A02006	PVC	 <p>ADD SPIKE</p> <p>Ø16.1mm</p> <p>Ø14mm</p> <p>64mm</p> <p>Ø4.1mm</p>	<p>DRIP CHAMBER Color :Light Blue Tinted A TYPE For Tube OD 4.05-4.15mm Gamma resistant</p>
A02007	PVC	 <p>ADD SPIKE</p> <p>Ø15.38mm</p> <p>Ø14mm</p> <p>80mm</p> <p>Ø4.1mm</p>	<p>DRIP CHAMBER Color :Light Blue Tinted A TYPE For Tube OD 4.05-4.15mm Gamma resistant</p>

Note :

Scale 1:1

ASSEMBLY

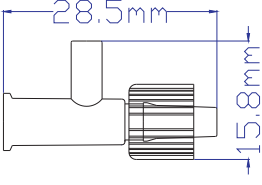
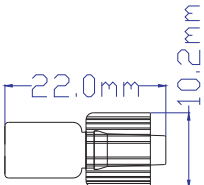
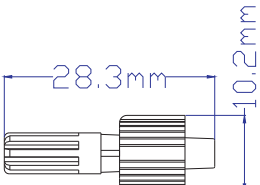
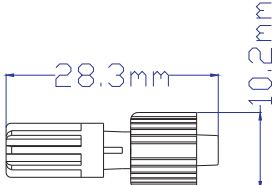
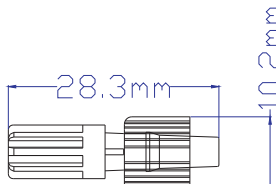
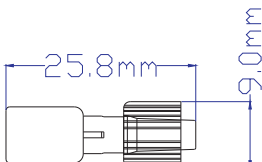
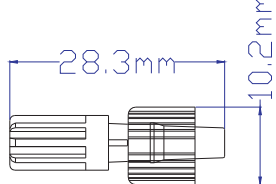
Code	Material	Product Drawing	Product Description
A04086	ABS		B+Y Connector ID4.1mm
A04087	ABS PVC		MINI-BI-CONNECTOR+ Luer Nut
A07097	ABS PVC		ROTATING MALE LUER LOCK ID2.4mm
A07098	ABS PVC		ROTATING MALE LUER LOCK ID3.5mm
A07099	ABS PVC		ROTATING MALE LUER LOCK ID4.1mm
A04045	ABS PC		Mini Bi-connector with Rotator ID 2.4MM
A07100	ABS PVC		ROTATING MALE LUER LOCK ID4.1mm

Note :

Scale 1:1

ASSEMBLY

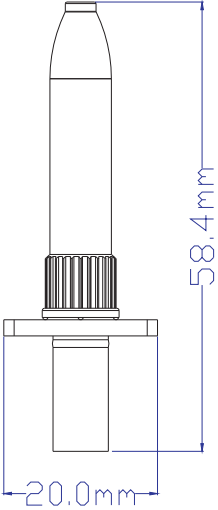
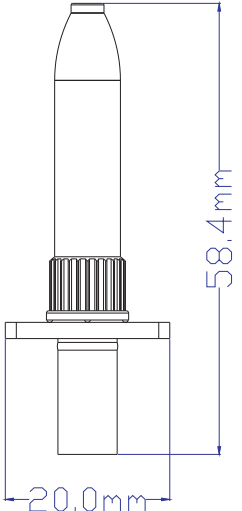
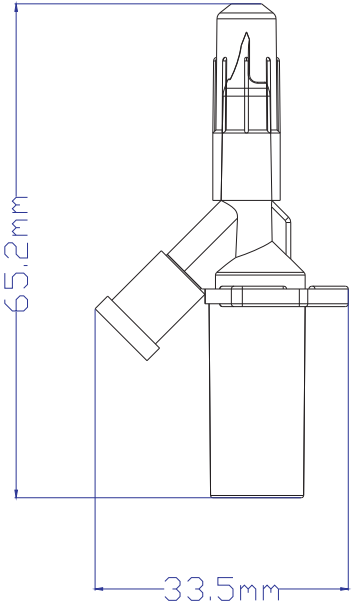
Code	Material	Product Drawing	Product Description
A08020	ABS LDPE		Non-vented Spike, Clear+Cover
A08027	LDPE Nylon		ROTATING MALE LUER LOCK ID3.5mm
A08028	ABS LDPE Silicone Acrylic Stainless Steel		HYPERAL PIERCING DEVICE Vented
Note :		Scale 1:1	

ASSEMBLY

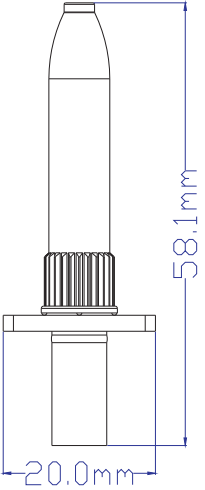
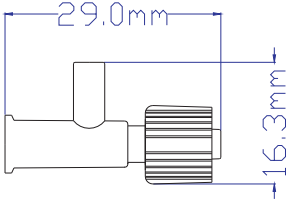
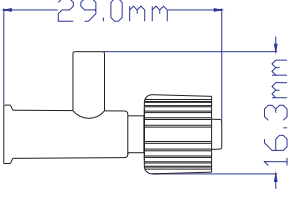
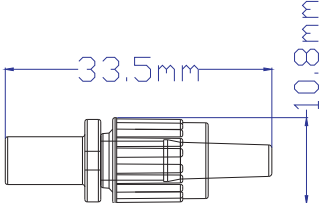
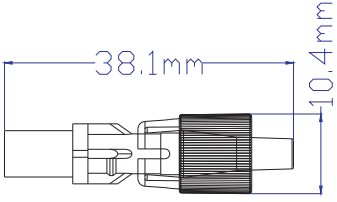
Code	Material	Product Drawing	Product Description
A08029	ABS LDPE		Non-Vented Spike A-Type+CAP
A04089	PVC PC		T-Injection Site/W Lock ID2.4mm
A04090	ABS PVC		T-Injection Site/W Lock ID2.4mm
A04091	ABS PVC		Male Slip ID 2.4mm+ Rotator B Type
A04048	ABS		Male Slip ID 4.1mm +Rotator C Type

Note :

Scale 1:1

ASSEMBLY

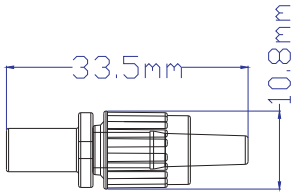
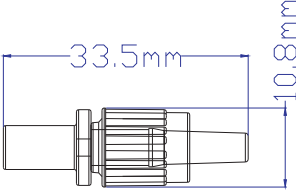
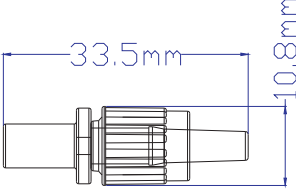
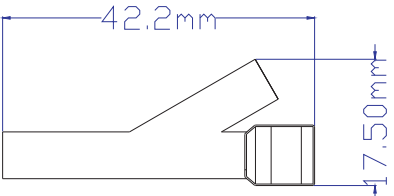
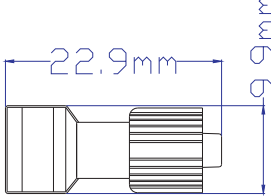
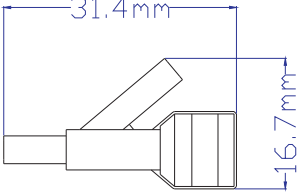
Code	Material	Product Drawing	Product Description
A04092	ABS PVC		Male Slip ID 3.5mm +Rotator B Type
A04093	ABS PVC		Male Slip ID 4.1mm +Rotator B Type
A04094	ABS PVC		Male Slip ID 5.5mm +Rotator B Type
A04095	ABS RUBBER		Y-Injection Site ID4.1mm
A04096	ABS RUBBER		Injection adapter assembly
A04097	ABS RUBBER		Y INJ. Site I. D2.4mm

Note :

Scale 1:1

ASSEMBLY

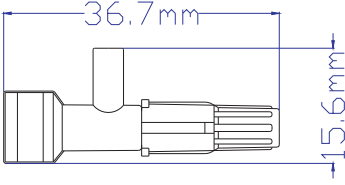
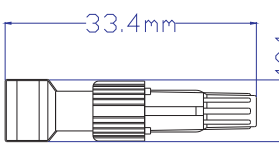
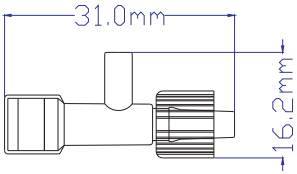
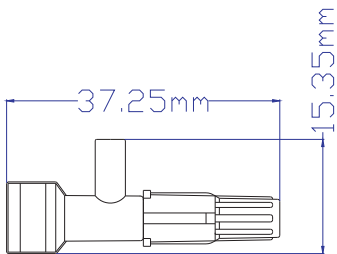
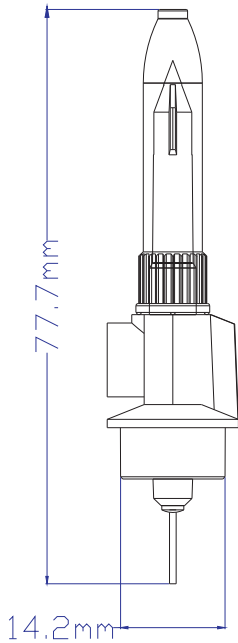
Code	Material	Product Drawing	Product Description
A04088	ABS LDPE RUBBER		"T" connector ID 2.4mm with cap and stopper
A04098	ABS LDPE RUBBER		INJECTION+CAP
A04099	ABS RUBBER		"T" connector ID 2.4mm W / INJECTION SITE +LUER NUT
A04100	ABS LDPE RUBBER		"T" connector ID 2.4mm W / INJECTION SITE, LATEX FREE
A08030	ABS LDPE RUBBER		Universal Spike with cap 60 drops, Vented

Note :

Scale 1:1

ASSEMBLY

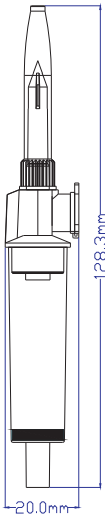
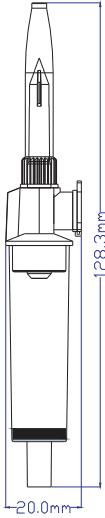
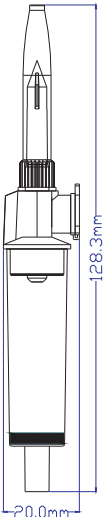
Code	Material	Product Drawing	Product Description
A08031	ABS LDPE PVC		<p>10 Drops Vented Drip Chamber With Filter Gamma resistant</p>
A08032	ABS LDPE PVC		<p>15 Drops Vented Drip Chamber With Filter Gamma resistant</p>
A08033	ABS LDPE PVC		<p>20 Drops Vented Drip Chamber With Filter Gamma resistant</p>

Note :

Scale 1:2

ASSEMBLY

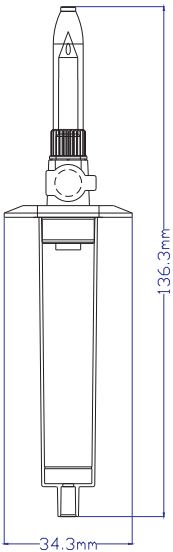
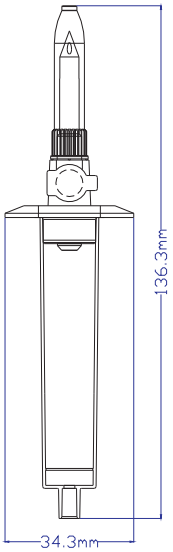
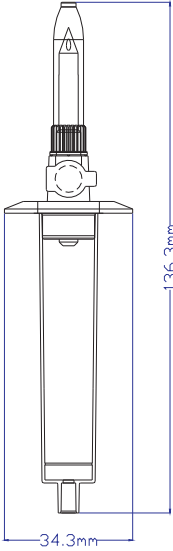
Code	Material	Product Drawing	Product Description
A08034	ABS LDPE PVC		<p>Universal Spike Module 10 DP + Drip ID4.1mm Gamma resistant</p>
A08035	ABS LDPE PVC		<p>Universal Spike Module 15 DP + Drip ID4.1mm Gamma resistant</p>
A08036	ABS LDPE PVC		<p>Universal Spike Module 20 DP + Drip ID4.1mm Gamma resistant</p>

Note :

Scale 1:2

ASSEMBLY

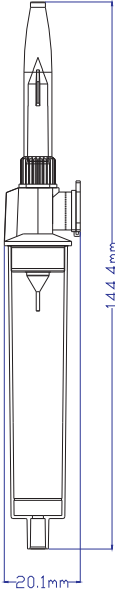
Code	Material	Product Drawing	Product Description
A08037	ABS LDPE PP PVC		60 Drops Vented Drip Chamber S.A. Gamma resistant

Note :

Scale 1:2

ASSEMBLY

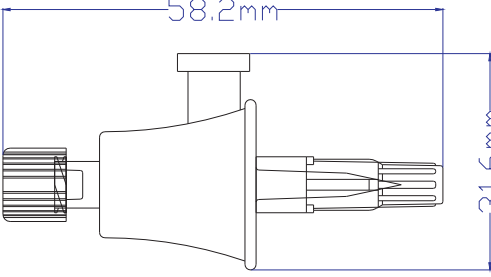
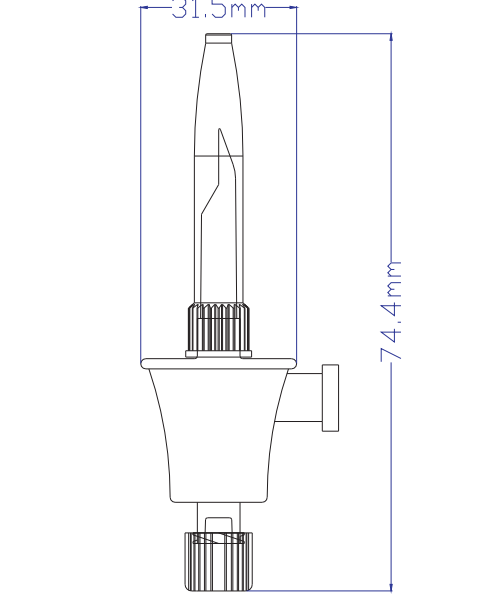
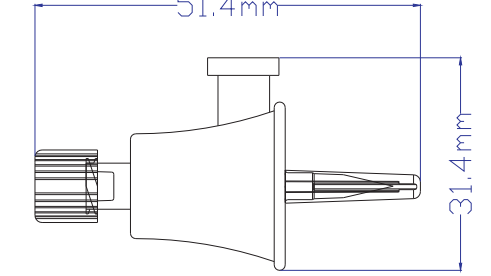
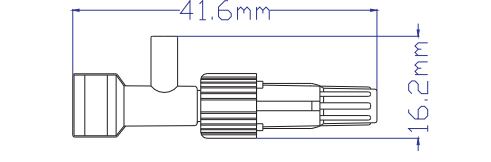
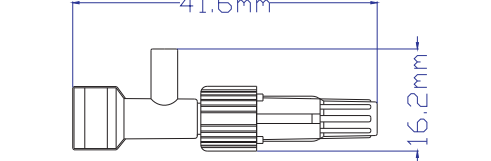
Code	Material	Product Drawing	Product Description
A08038	ABS HDPE LDPE		Medium Transfer Spike Filter:3 um
A08039	ABS HDPE LDPE		Large Transfer Spike Filter:3 um
A08040	ABS HDPE LDPE		Mini Transfer Spike Filter:3 um
A04101	ABS LDPE RUBBER		T-Injection Site/W Lock ID2.4mm
A04102	PC LDPE RUBBER		T-Injection Site/W Lock ID2.4mm

Note :

Scale 1:1

ASSEMBLY

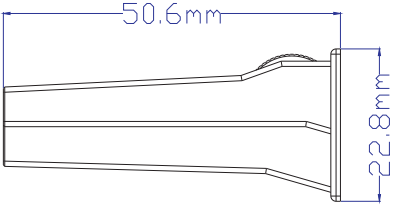
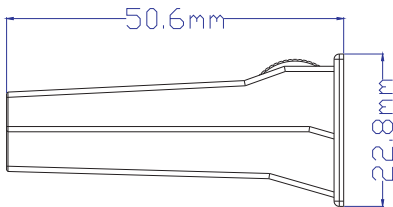
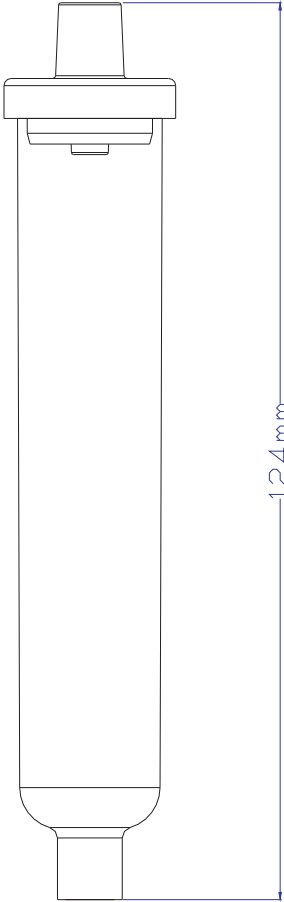
Code	Material	Product Drawing	Product Description
A03045	ABS		<p>Roller Clamp Roller Body(White) Roller (White)</p>
A03046	ABS		<p>Roller Clamp Roller Body(Red) Roller (White)</p>
A02008	PVC		<p>Drip Chamber Assembly ID 6.7mm Color:Light Blue Tinted For Tube OD 6.65-6.75mm</p>

Note :

Scale 1:1

ASSEMBLY

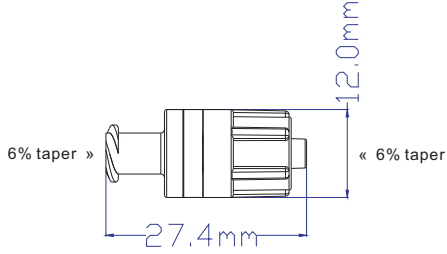
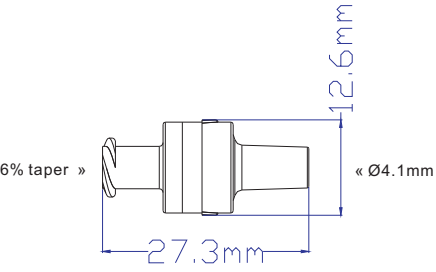
Code	Material	Product Drawing	Product Description
A04103	PC Silicone		Single Check Valve
A04104	PC Silicone		Single Check Valve

Note :

Scale 1:1